

SUNDAY

2025



Печьру



ALLORO _ PALMA



ALLORO 210 EXTENSIBILE _ PALMA







LIBECCIO _ BORA



LIBECCIO _ BORA





LIBECCIO _ BORA



LIBECCIO



STEP _ DARSENA



STEP_DARSENA





ALFA _ OMEGA



ALFA



OMEGA

NARDI

24



OMEGA

NARDI

25

TECHNICAL
DETAILS

BORA

fiberglass polypropylene

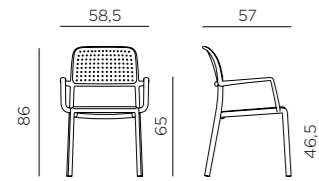

4,4 kg
n. pz. 6



BIANCO 40242.00.000.06
ANTRACITE 40242.02.000.06
TORTORA 40242.10.000.06
AGAVE 40242.16.000.06
CELESTE 40242.39.000.06

BORA BISTROT

fiberglass polypropylene

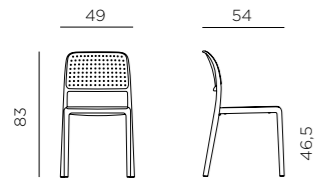

3,7 kg
n. pz. 6



BIANCO 40243.00.000.06
ANTRACITE 40243.02.000.06
TORTORA 40243.10.000.06
AGAVE 40243.16.000.06
CELESTE 40243.39.000.06

RIVA

fiberglass polypropylene

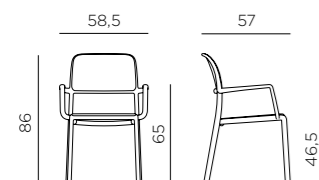

4,6 kg
n. pz. 6



BIANCO 40246.00.000.06
ANTRACITE 40246.02.000.06
ROSSO 40246.07.000.06
TORTORA 40246.10.000.06
AGAVE 40246.16.000.06
CELESTE 40246.39.000.06

RIVA BISTROT

fiberglass polypropylene

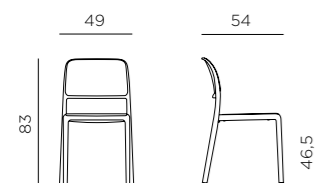

4 kg
n. pz. 6



BIANCO 40247.00.000.06
ANTRACITE 40247.02.000.06
ROSSO 40247.07.000.06
TORTORA 40247.10.000.06
AGAVE 40247.16.000.06
CELESTE 40247.39.000.06

COSTA

fiberglass polypropylene

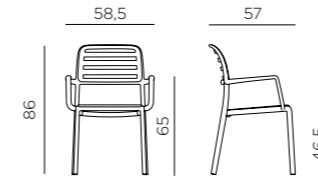

4,5 kg
n. pz. 6



BIANCO 40244.00.000.06
ANTRACITE 40244.02.000.06
TORTORA 40244.10.000.06
AGAVE 40244.16.000.06
CELESTE 40244.39.000.06

COSTA BISTROT

fiberglass polypropylene

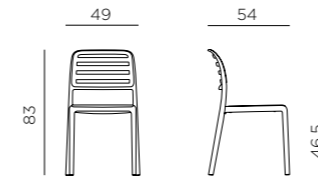

3,9 kg
n. pz. 6



BIANCO 40245.00.000.06
ANTRACITE 40245.02.000.06
TORTORA 40245.10.000.06
AGAVE 40245.16.000.06
CELESTE 40245.39.000.06

DARSENA

fiberglass polypropylene

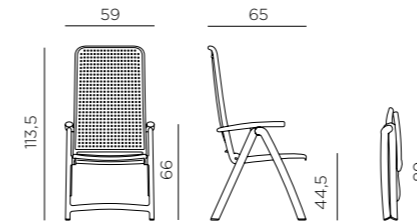

7,7 kg
n. pz. 1



BIANCO 40316.00.000
ANTRACITE 40316.02.000
TORTORA 40316.10.000

CUSCINO DARSENA

fabric

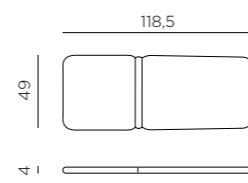

0,8 kg
n. pz. 4



bianco 36316.00.155
grigio # 36316.00.163
grigio Sunbrella® 36316.00.136

Variazioni di colore sono da ritenersi standard e naturali nei tessuti acrilici tinto filo. Posizionare in zone d'ombra - Colour variations are to be considered standard and natural in yarn-dyed acrylic fabrics. Position in shaded areas - Les variations de couleur des tissus acryliques au fil teint sont standard et naturelles. Placer dans des zones ombragées - Farbveränderungen sind als Standard und in im Garn gefärbten Acrylgeweben als natürlich zu betrachten. In schattigen Bereichen aufstellen - Las variaciones de color son normales y naturales en las telas acrílicas teñidas en hilo. Colocar en zonas de sombra - As variações de cor são consideradas standard e naturais nos tecidos acrílico tingidos com fio. Posicionar em zonas de sombra - Boyalı akrilik iplik kumaşlarda renk değişiklikleri standart ve doğal kabul edilir. Gölgeli alanlara yerleştiriniz - Изменения цвета следует считать нормой, они являются естественными в случае акриловых тканей с окрашенными волокнами. Размещать в тени

PALMA

polypropylene

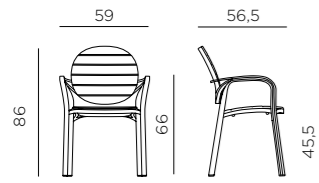

5,2 kg
n. pz. 6



BIANCO
40237.00.000

BIANCO TORTORA
40237.00.010

ANTRACITE
40237.02.002

TORTORA
40237.10.010

ERICA

polypropylene

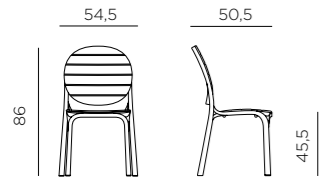

4,1 kg
n. pz. 6



BIANCO
40236.00.000

BIANCO TORTORA
40236.00.010

ANTRACITE
40236.02.002

TORTORA
40236.10.010

ALLORO 210 EXTENSIBLE 8/10

durelTOP / polypropylene / aluminium

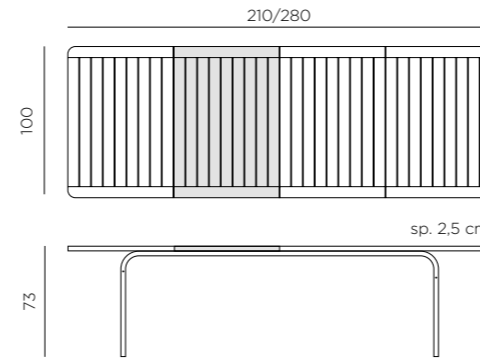

44,5 kg
n. pz. 1



BIANCO
verniciato bianco
42853.00.000



TORTORA
verniciato bianco
42853.10.000



ANTRACITE ✖
verniciato antracite
42852.02.000



TORTORA
verniciato tortora
42859.10.000

ALLORO 140 EXTENSIBLE 6/8

durelTOP / polypropylene / aluminium

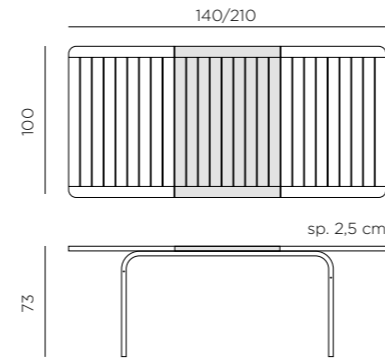

33,7 kg
n. pz. 1



BIANCO
verniciato bianco
42753.00.000



TORTORA
verniciato bianco
42753.10.000



ANTRACITE ✖
verniciato antracite
42752.02.000



TORTORA
verniciato tortora
42759.10.000

✖ Posizionare in zone d'ombra - Position in shaded areas - Placer dans des zones ombragées - In schattigen Bereichen aufstellen - Colocar en zonas de sombra - Posicionar em zonas de sombra - Gölgele alanlara yerleştiriniz - Размещать в тени

LIBECCIO 6/8

durelTOP / polypropylene / aluminium

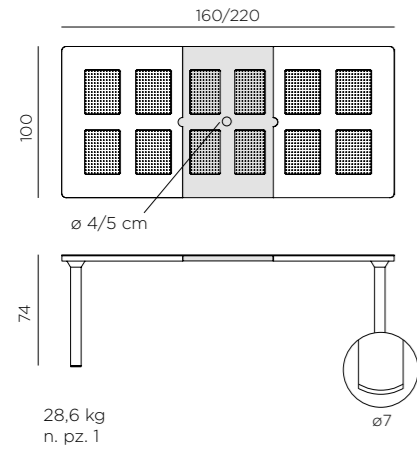

BIANCO
verniciato bianco
47553.00.000

ANTRACITE*
verniciato antracite
47552.02.000

TORTORA
verniciato tortora
47559.10.000

STEP

fiberglass polypropylene

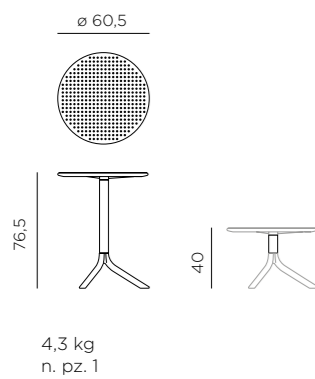

BIANCO
40056.00.000

ANTRACITE
40056.02.000

TORTORA
40056.10.000

AGAVE
40056.16.000

CELESTE
40056.39.000

4,3 kg
n. pz. 1

SPRITZ

fiberglass polypropylene

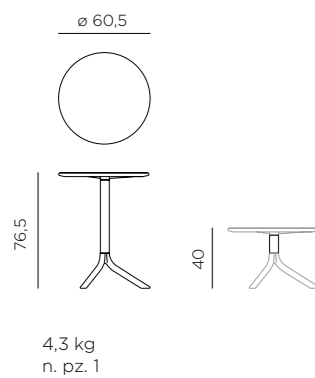

BIANCO
40058.00.000

ANTRACITE
40058.02.000

ROSSO
40058.07.000

TORTORA
40058.10.000

AGAVE
40058.16.000

CELESTE
40058.39.000

4,3 kg
n. pz. 1

ALFA

polypropylene / synthetic fabric

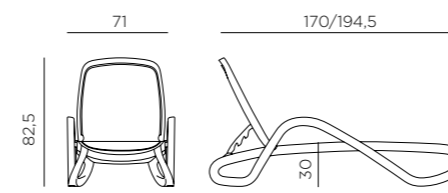

14 kg
n. pz. 13,5

Tessuto ricambiabile
Replaceable fabric
Tissu changeable
Auswechselbarer Stoff
Tela sustituible
Técidos recambiáveis
Değiştirilebilen Kumaş
Съемная ткань

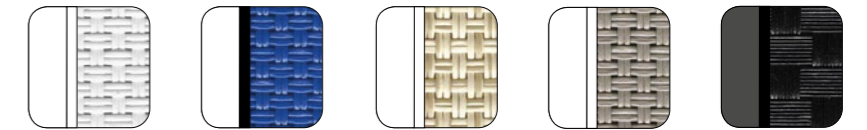

BIANCO
bianco
40416.00.108

BIANCO
blu
40416.00.112

BIANCO
beige
40416.00.115

BIANCO
tortora
40416.00.124

ANTRACITE
trama antracite
40416.02.116

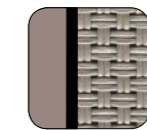

TORTORA
tortora
40416.10.124

OMEGA

polypropylene / synthetic fabric

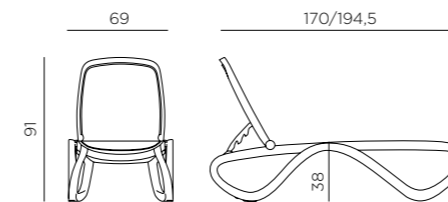

13,5 kg
n. pz. 18

Tessuto ricambiabile
Replaceable fabric
Tissu changeable
Auswechselbarer Stoff
Tela sustituible
Técidos recambiáveis
Değiştirilebilen Kumaş
Съемная ткань

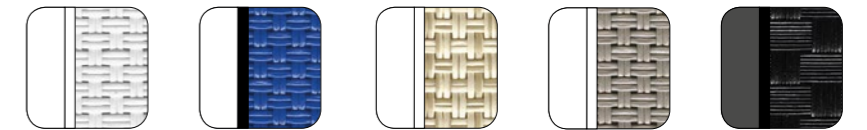

BIANCO
bianco
40417.00.108

BIANCO
blu
40417.00.112

BIANCO
beige
40417.00.115

BIANCO
tortora
40417.00.124

ANTRACITE
trama antracite
40417.02.116



TORTORA
tortora
40417.10.124

* Posizionare in zone d'ombra - Position in shaded areas - Placer dans des zones ombragées - In schattigen Bereichen aufstellen - Colocar en zonas de sombra - Posicionar em zonas de sombra - Gölge alanlara yerleştiriniz - Размещать в тени

PARASOLE

ALFA - OMEGA

polypropylene / synthetic fabric

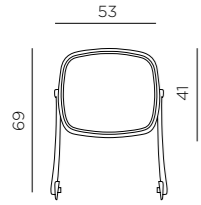

1,4 kg
n. pz. 1

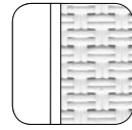

BIANCO
bianco
40418.00.108

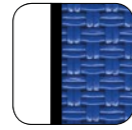

BIANCO
blu
40418.00.112

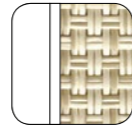

BIANCO
beige
40418.00.115

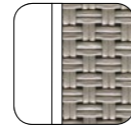

BIANCO
tortora
40418.00.124

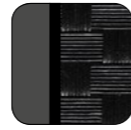

ANTRACITE
trama antracite
40418.02.116



TORTORA
tortora
40418.10.124

RICAMBIO

ALFA - OMEGA

acetalic resin / synthetic fabric

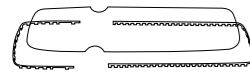

1,6 kg
n. pz. 1

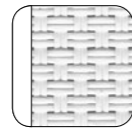

bianco
40424.00.108

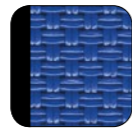

blu
40424.00.112

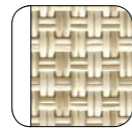

beige
40424.01.115

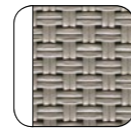

tortora
40424.00.124

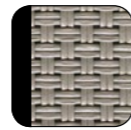

tortora
40424.01.124

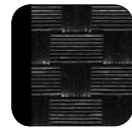

trama antracite
40424.00.116

COVER SMALL

(4/6 CHAIRS / 1 ELEMENT SOFA)

fabric

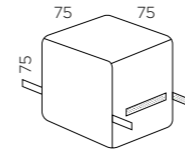

0,7 kg
n. pz. 25



smoke
37000.01.204

COVER MEDIUM

(2/4 SUNLOUNGERS)

fabric

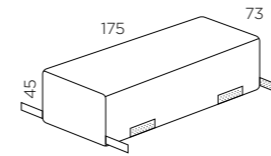

0,8 kg
n. pz. 20



smoke
37000.02.204

COVER LARGE

(2 ELEMENT SOFA / TABLE 140)

fabric

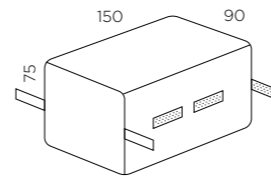

1,1 kg
n. pz. 20



smoke
37000.03.204

COVER EXTRALARGE

(3 ELEMENT SOFA / TABLE 210)

fabric

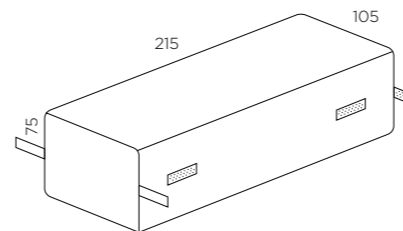

1,6 kg
n. pz. 15



smoke
37000.04.204

MATERIALS

polypropylene

Polipropilene trattato anti-UV e colorato in massa. Riciclabile al 100% - Polypropylene with UV additives and is uniformly colored. 100% Recyclable resin - Polypropylène traité anti-UV et coloré dans la masse. Résine recyclable 100% - UV-beständigem Polypropylen, voll durchgefärbt. 100% Recyclebarer Kunststoff - Polipropileno tratado anti-UV y teñido en masa. Resina reciclable 100% - Polipropileno com tratamento anti-UV colorido na totalidade. Resina reciclável 100% - Işığa dayanıklı ve boyalı olarak granül çekilmiş %100 geri dönüşümlü polipropilen kompozit hammadde - Полипропилен с обработкой анти-УФ, окрашенное в массе. На 100% пригодно для вторичной переработки.

fiberglass polypropylene

Polipropilene fiberglass trattato anti-UV e colorato in massa. Resina riciclabile al 100% - Uniformly colored fiberglass polypropylene resins with UV additives. 100% Recyclable resin - Polypropylène fiberglass traité anti-UV et coloré dans la masse. Résine recyclable 100% - Uv-beständigem fiberglass Polypropylen, voll durchgefärbt. 100% Recyclebarer Kunststoff - Polipropileno fiberglass tratado anti-UV y teñido en masa. Resina reciclable 100% - Polipropileno fiberglass com tratamento anti-UV colorido na totalidade. Resina reciclável 100% - Işığa dayanıklı ve boyalı olarak granül çekilmiş %100 geri dönüşümlü cam elyaf katkılı polipropilen kompozit hammadde - Полипропилен фиброволокно с обработкой анти-УФ, окрашенное в массе. На 100% пригодно для вторичной переработки.

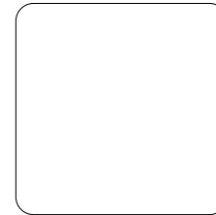

BIANCO .00



GRIGIO .03



ANTRACITE .02



TORTORA .10



ROSSO .07



AGAVE .16



CELESTE .39

acrylic fabric



Fibra acrilica 100% tinto filo. Trattamento antimacchia, antimuffa. Solidità alla luce 5/8. Lavabile a 30° - 100% yarn dyed acrylic. Dirt repellent and anti-mould treatment. 5/8 light fastness. Washable at 30° - 100% fibre acrylique teintée en fils. Traitement anti-taches et anti-moisissure. Résistance à la lumière 5/8. Lavable à 30° - 100% garnggefärbtes Polyacryl Gewebe. Gegen Flecken und Schimmel Ausrüstung. Lichtechtheit 5/8. Waschbar bei 30° - 100% hilo teñido

acrílico. Protección antimanchas, antimoho. Solidez a la luz 5/8. Lavable a 30° - 100% fibra acrílica tingida com fio. Tratamento antimancha e antimoho. Resistência à luz 5/8. Lavável a 30° - %100 akrilik elyaf boyalı iplik. Leke itici, küf önleyici ile muamele edilmiş. Işık haslığı 5/8. 30°de yıkanabilir - Акриловое волокно 100% окрашенное в пряже. Пятноустойчивая и противогрибковая обработка. Светостойкость 5/8. Стирать при 30°.

Variazioni di colore sono da ritenersi standard e naturali nei tessuti acrilici tinto filo. Posizionare in zone d'ombra - Colour variations are to be considered standard and natural in yarn-dyed acrylic fabrics. Position in shaded areas - Les variations de couleur des tissus acryliques au fil teint sont standard et naturelles. Placer dans des zones ombragées - Farbveränderungen sind als Standard und in im Garn gefärbten Acrylgeweben als natürlich zu betrachten. In schattigen Bereichen aufstellen - Las variaciones de color son normales y naturales en las telas acrílicas teñidas en hilo. Colocar en zonas de sombra - As variações de cor são consideradas standard e naturais nos tecidos acrílico tingidos com fio. Posicionar em zonas de sombra - Boyalı akrilik iplik kumaşlarda renk değişiklikleri standart ve doğal kabul edilir. Gölgeli alanlara yerleştiriniz - Изменения цвета следует считать нормой, они являются естественными в случае акриловых тканей с окрашенными волокнами. Размещать в тени.

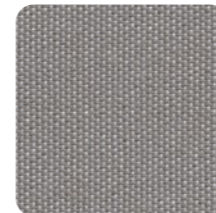

grigio .163
240 gr/m²

Sunbrella® acrylic fabric



100% fibra acrilica Sunbrella® tinto in massa. Trattamento idrorepellente, antimacchia, antimuffa. Solidità alla luce 8/8. Lavabile a 30° - 100% Sunbrella® acrylic fiber mass dyed. Water repellent treatment, dirt repellent and anti-mould treatment. 8/8 light fastness. Washable at 30° - 100% fibre acrylique Sunbrella® teintée en masse. Traitement imperméable, anti-taches et anti-moisissure. Résistance à la lumière 8/8. Lavable à 30° - 100% fasergefärbtes Sunbrella® Polyacryl. Wasserabweisend Ausrüstung, gegen Flecken und Schimmel ausgerüstet. Lichtechtheit 8/8. Waschbar bei 30° - 100% fibra

acrílica Sunbrella® tintada en masa. Tratamiento por la repelencia al agua, protección antimanchas, antimoho. Solidez a la luz 8/8. Lavable a 30° - 100% fibra acrílica Sunbrella® tingida em massa. Tratamento hidropelente, antimancha e antimoho. Resistência à luz 8/8. Lavável a 30° - %100 akrilik elyaf Sunbrella® çözelti halindeyken boyanmış. Su itici, leke itici, küf önleyici ile muamele edilmiş. Işık haslığı 8/8. 30°de yıkanabilir - 100% акриловое волокно Sunbrella®, окрашенное в массе. Водоотталкивающая, пятноустойчивая и противогрибковая обработка. Светостойкость 8/8. Стирать при 30°.



grigio Sunbrella® .136
275 gr/m²

100% Olefin fabric

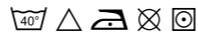

100% Olefin tinto in massa. Trattamento antimacchia, antimuffa. Solidità alla luce 7/8. Lavabile a 40° - 100% Olefin mass dyed. Dirt repellent and anti-mould treatment. 7/8 light fastness. Washable at 40° - 100% Olefin teintée en masse. Traitement anti-taches et anti-moisissure. Résistance à la lumière 7/8. Lavable à 40° - 100% fasergefärbtes Olefin. Gegen Flecken und Schimmel ausgerüstet. Lichtechtheit 7/8. Waschbar bei 40° - 100% Olefin tintada

en masa. Protección antimanchas, antimoho. Solidez a la luz 7/8. Lavable a 40° - 100% Olefin tingida em massa. Tratamiento antimancha e antimoho. Resistência à luz 7/8. Lavável a 40° - %100 Olefin çözelti halindeyken boyanmış. Leke itici, küf önleyici ile muamele edilmiş. Işık haslığı 7/8. 40°de yıkanabilir - 100% Olefin, окрашенный в массе. Пятноустойчивая и противогрибковая обработка. Светостойкость 7/8. Стирать при 40°.



bianco .155
190 gr/m²

padding

cuscinò darsena

Poliuretano espanso. Densità 28 kg/m³ - Polyurethane foam. Density 28 kg/m³ - Mousse polyuréthane. Densité 28 kg/m³ - Polyurethanschaum. Dichte 28 kg/m³ - Espuma de poliuretano. Densidad 28 kg/m³ - Espuma de poliuretano.

Densidade 28 kg/m³ - Poliüretan köpük. Yoğunluk 28 kg/m³. Пенополиуретан. Плотность 28 кг/м³.

NARDI

synthetic fabric

Tessuto in filo di poliestere rivestito in pvc - Fabric is made of a polyester fiber, with a pvc coating - Tissu en fil de polyester revêtu de pvc - Gewebe aus PVC-ummantelten Polyesterfasern - Tejido en hilo de poliéster recubierto

de pvc - Tecido de fibra polyester com cobertura pvc - PVC kaplı polyester elyaf tekstil - Ткань из полиэфирных нитей с покрытием из ПВХ.

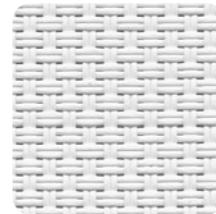

bianco .108
tela 2x2



beige .115
tela 2x2



tortora .124
tela 2x2



blu .112
tela 2x2

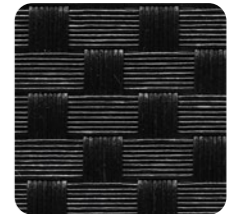

trama antracite .116

Cover fabric



56% poliestere e 44% poliuretano. Trattamento idrorepellente, antimacchia, antimuffa e antibatterico. Solidità alla luce 7/8. Lavabile a 95° con detergente neutro - 56% polyester and 44% polyurethane. The treatment makes the coating: water repellent, and resistant to staining, resistant to mold and antibacterial. 7/8 light fastness. Washable at 95° with neutral detergent - 56% polyester et 44% polyuréthane. Traitement imperméable, anti-taches, anti-moisissures et antibactérien. Résistance à la lumière 7/8. Lavable à 95° avec un détergent neutre - 56% Polyester und 44% Polyurethan. Wasserabweisend, gegen Flecken und Schimmelbildung ausgerüstet und antibakteriell. Lichtechtheit 7/8. Waschbar bei 95° mit Neutralwaschmittel - 56%

poliéster y 44% poliuretano. Tratamiento para repeler el agua, antimanchas, antimoho y antibacteriano. Solidez a la luz 7/8. Lavable a 95° con detergente neutro - 56% de poliéster e 44% poliuretano. Tratamiento hidropelente, antimancha, antimoho e antibacteriano. Resistência à luz 7/8. Lavável a 95° com detergente neutro - % 56 polyester ve % 44 poliüretan. Su Geçirmez Uygulama, kir tutmaz ve küf önleyici uygulama, antibakteriyel uygulama. Işık haslığı 7/8. Naturel deterjanla 95°de yıkanabilir - 56% полиэстер и 44% полиуретан. типы обработки: водоталкивающая, пятноталкивающая, плесеньоталкивающая, и антибактериальная устойчивость к. Светостойкость 7/8. Можно стирать при 95° с нейтральным моющим средством.



smoke .204
205 gr/m²

coated aluminium

La verniciatura è a polvere di poliestere - The painting is with polyester powder - La peinture est à poudre de polyester - Die Epoxierung erfolgt mit Polyesterpulver - El pintado se realiza con polvo de poliéster - O pó de poliéster è

usado para envernizar - Boyası polyester tozla yapılır - Окраска производится при помощи порошкового полиэстера.



verniciato bianco .53



verniciato antracite .52



verniciato tortora .59

NARDI

durelTOP

DurelTOP è un sistema innovativo di produzione di piani per tavoli studiati per raggiungere i più elevati livelli di praticità, resistenza, robustezza ed eleganza. I piani DurelTOP sono ad alto spessore, formati da un doppio strato tamburato perfettamente chiuso. Prodotti in polipropilene di prima qualità, sono inalterabili all'acqua, resistenti al sole e facili da pulire. DurelTOP è il risultato di una lunga ricerca tecnologica e dell'esperienza decennale nella lavorazione delle materie plastiche della NARDI, da sempre all'avanguardia nell'ambiente contract e giardino.

The DurelTOP is an innovative new system in the production of tabletops developed to reach the highest levels of practicality, resistance, and elegance. The DurelTOP tabletops have a greater thickness, formed by a double layer enclosure perfectly closed. Produced in first quality polypropylene, they are resistant to water, resistant to sunlight, and are easy to clean. DurelTOP is a result of a decade's long research and development in plastics by NARDI, always a leader in the contract and garden sectors.

DurelTOP est un système innovateur de production de plateaux de tables, il est étudié pour retrouver le meilleur niveau de pratique de résistance et d'élégance. Les plateaux DurelTOP sont très épais, formés de doubles couches parfaitement finies. Ce sont des produits en polypropylène de première qualité, ils sont inaltérables à l'eau, résistant au soleil et faciles à nettoyer. DurelTOP est le résultat d'une longue recherche technologique et une expérience décennale dans le travail des matières plastique de la Sté NARDI, toujours a l'avant-garde dans le secteur du contract et jardin.

DurelTOP ist ein neu entwickeltes System für die Produktion von Tischplatten, um ein Höchstmaß an Funktionalität, Widerstandsfähigkeit und Eleganz zu erreichen. Durch das innen verstärktes "Zwei-Schichten-Hohlraum-System" erreicht die DurelTOP Tischplatte einen stärkeren Querschnitt und damit ein Höchstmaß an Festigkeit. Hergestellt aus hochwertigem Qualitätspolypropylen ist sie resistent gegen Wasser und Sonnenlicht und dabei leicht zu reinigen. DurelTOP ist das Ergebnis von 10 Jahren Forschung und Entwicklung auf dem Kunststoffsektor durch NARDI, immer der führende im Bereich Contract- und Gartenmöbel.

DurelTOP es un nuevo sistema de fabricaciòn de tableros de mesa estudiado para alcanzar los mas alstos niveles de practicidad, resistencia, robustez y elegancia. Los tableros DurelTOP de gran solidez, estan formados por una doble capa perfectamente unida y sellada. Fabricados en polipropileno de primera calidad son inalterables al agua, resistentes al sol y de fácil limpieza. DurelTOP es el resultado de una prolongada investigaciòn tecnológica y de la experiencia acumulada en los mas de diez años que NARDI lleva produciendo materias plasticas, siempre innovando en ambientes contract y jardín.

DurelTOP é um sistema de inovaçãõ da produçãõ de tampos de mesa concebidos para atingir a máxima resistênciã,práticos e elegantes. Os tampos de mesa DurelTOP são formados poruma camada dupla e perfeitamente unida. Produzidos em polipropileno de primeira qualidade, são resistentes ao sol e fáceis de limpar. DurelTOP é o resultado de uma longa investigação tecnológica em materiais plásticos da NARDI, leader em mobiliário de jardim.

DurelTOP, masa tablalarının üretiminde kullanılan yeni bir sistem olup, yüksek seviyede pratiklik, direnç ve de şıklık sunmak amacıyla geliştirilmiştir. DurelTOP masa tablaları fevkalade bir inceliğe sahip olup, kusursuz kapanan çift tabaka çevirme sistemiyle oluşturulmuştur. Nitelikli çamsakızından üretilmiş olup, suya ve güneş ışığına karşı dirençli ve temizlenmesi kolaydır. DurelTOP sistemini Contract ve de Bahçe sektöründe her zaman lider olan NARDI'nin uzun araştırmalarının sonucundan doğan, plastikte gelişim olarak adlandırabiliriz.

DurelTOP — это инновационная система производства столешниц, позволяющая изготавливать практичные, прочные, крепкие и элегантные столешницы.

Столешницы DurelTOP обладают высокой плотностью и состоят из двойной панели с мелкопустотным заполнением, полностью закрытой. Изделия из полипропилен высокого качества устойчивы к воде, солнцу и просты в уходе. DurelTOP — это результат многолетних технологических исследований и десятилетнего опыта NARDI в обработке пластмасс, лидера в производстве садовой мебели и контрактном секторе.

	NARDI
	DurelTOP

	NARDI
	DurelTOP

Свяжитесь с нами



8 (495) 215-57-60



8 (800) 333-63-19



info@pech.ru



<https://www.pech.ru/>

Печь•ру