

1. Straight pipe 1000 [mm] RP

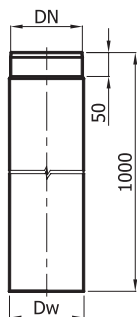

Diameter DN	Ø120	Ø130	Ø150	Ø160	Ø180	Ø200	Ø220	Ø250
Dw	121.0	131.0	151.0	161.0	181.0	201.0	221.0	251.0
Weight [kg]	6.20	6.70	7.70	8.20	9.20	10.25	11.20	12.70

Denotations / product codes

RP x/1000-CZ 2

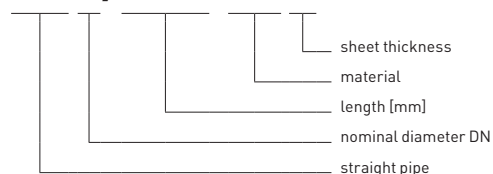

Destination	D	D - smoke ducts
Material	CZ	CZ - mild steel DC01
Sheet thickness s	2	2 - sheet thickness 2,0 mm

2. Straight pipe 500 [mm] RP

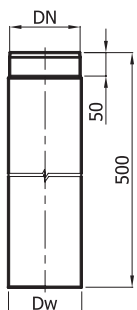

Diameter DN	Ø120	Ø130	Ø150	Ø160	Ø180	Ø200	Ø220	Ø250
Dw	121.0	131.0	151.0	161.0	181.0	201.0	221.0	251.0
Weight [kg]	3.10	3.35	3.85	4.20	4.60	5.10	5.60	6.35

Denotations / product codes

RP x/500-CZ 2

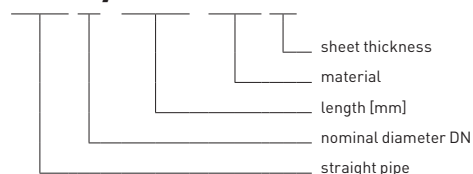

Destination	D	D - smoke ducts
Material	CZ	CZ - mild steel DC01
Sheet thickness s	2	2 - sheet thickness 2,0 mm

3. Straight pipe 250 [mm] RP

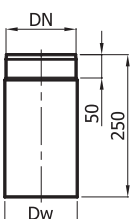

Diameter DN	Ø120	Ø130	Ø150	Ø160	Ø180	Ø200	Ø220	Ø250
Dw	121.0	131.0	151.0	161.0	181.0	201.0	221.0	251.0
Weight [kg]	1.55	1.70	1.95	2.10	2.30	2.55	2.80	3.18

Denotations / product codes

RP x/250-CZ 2

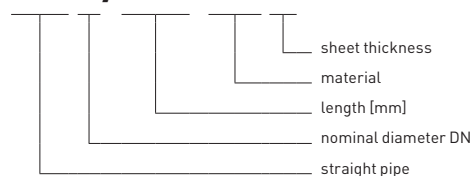

Destination	D	D - smoke ducts
Material	CZ	CZ - mild steel DC01
Sheet thickness s	2	2 - sheet thickness 2,0 mm

4. Straight pipe with revision 1000, 500, 250 [mm] RPr

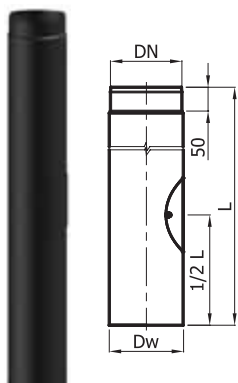

Diameter DN	Ø120	Ø130	Ø150	Ø160	Ø180	Ø200	Ø220	Ø250
Dw	121.0	131.0	151.0	161.0	181.0	201.0	221.0	251.0
Weight for 1000 mm [kg]	1.55	1.70	1.95	2.10	2.30	2.55	2.80	3.18

Denotations / product codes

RPr x/L-CZ 2

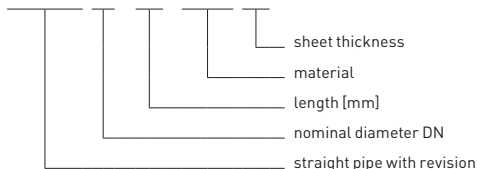

Destination	D	D - smoke ducts
Material	CZ	CZ - mild steel DC01
Sheet thickness s	2	2 - sheet thickness 2,0 mm

5. Radiator pipe 500 [mm] RPŻ

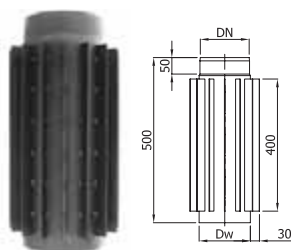

Diameter DN	Ø120	Ø130	Ø150	Ø160	Ø180	Ø200	Ø220	Ø250
Dw	121.0	131.0	151.0	161.0	181.0	201.0	221.0	251.0
Weight [kg]	6.0	6.30	6.55	6.80	7.70	8.60	9.25	10.00

Denotations / product codes

RPŻ x/500-CZ 2

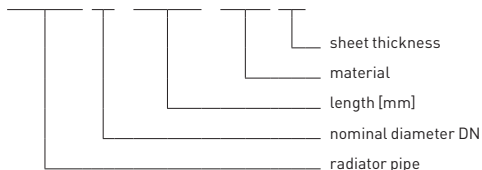

Destination	D	D - smoke ducts
Material	CZ	CZ - mild steel DC01
Sheet thickness s	2	2 - sheet thickness 2,0 mm

6. Tee 90° TR/90



Diameter DN	Ø120	Ø130	Ø150	Ø160	Ø180	Ø200	Ø220	Ø250
Dw	121.0	131.0	151.0	161.0	181.0	201.0	221.0	251.0
L [mm]	200	200	200	200	200	175	175.0	175.0
Weight [kg]	4.40	4.70	5.40	5.85	6.45	6.90	7.20	8.30

Denotations / product codes

TR x/90-CZ 2

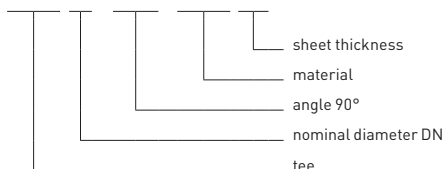

Destination	D	D - smoke ducts
Material	CZ	CZ - mild steel DC01
Sheet thickness s	2	2 - sheet thickness 2,0 mm

7. Tee 45° TR/45



Diameter DN	Ø120	Ø130	Ø150	Ø160	Ø180	Ø200	Ø220	Ø250
Dw	121.0	131.0	151.0	161.0	181.0	201.0	221.0	251.0
L [mm]	150.0	150.0	150.0	150.0	150.0	150.0	180.0	120.0
Weight [kg]	3.10	3.40	3.90	4.20	4.60	5.10	7.55	8.70

Denotations / product codes

TR x/45-CZ 2

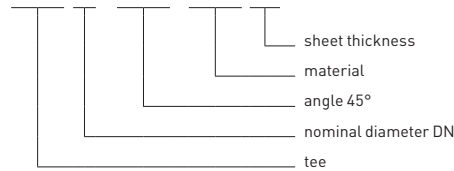

Destination	D	D - smoke ducts
Material	CZ	CZ - mild steel DC01
Sheet thickness s	2	2 - sheet thickness 2,0 mm

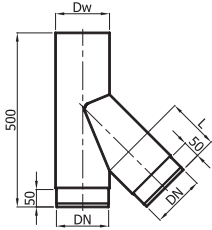

8. Twin-flow tee TRM



Diameter DN	Ø120	Ø130	Ø150	Ø160	Ø180	Ø200	Ø220	Ø250
Dw	121.0	131.0	151.0	161.0	181.0	201.0	221.0	251.0
L [mm]	200.0	200.0	200.0	200.0	200.0	175.0	180.0	120.0
Weight [kg]	4.90	5.30	6.10	6.50	7.35	7.95	8.35	8.70

Denotations / product codes

TRM x/90-CZ 2

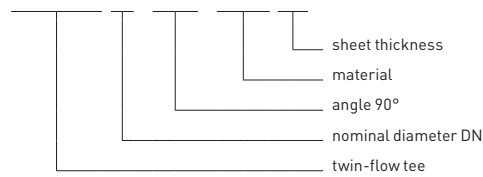

Destination	D	D - smoke ducts
Material	CZ	CZ - mild steel DC01
Sheet thickness s	2	2 - sheet thickness 2,0 mm

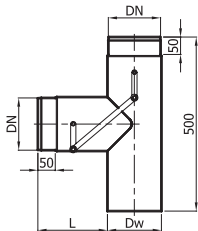

9. Twin-flow tee TRDW



Diameter DN	Ø120	Ø130	Ø150	Ø160	Ø180	Ø200	Ø220	Ø250
Dw	121.0	131.0	151.0	161.0	181.0	201.0	221.0	251.0
Weight [kg]	3.20	3.50	4.15	4.40	5.25	6.00	6.50	7.00

Destination	D	D - smoke ducts
Material	CZ	CZ - mild steel DC01
Sheet thickness s	2	2 - sheet thickness 2,0 mm

Denotations / product codes

TRDW x/90-CZ 2

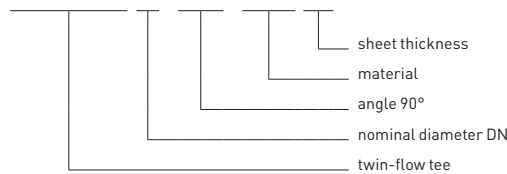

Detail L

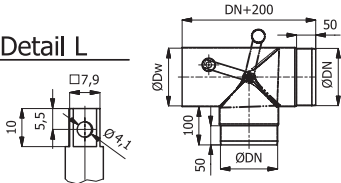

Detail K

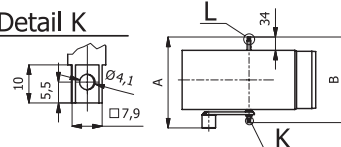

10. Adjustable elbow 90° with revision KNSR/90



Diameter DN	Ø120	Ø130	Ø150	Ø160	Ø180	Ø200	Ø220	Ø250
Dw	121.0	131.0	151.0	161.0	181.0	201.0	221.0	251.0
b1 [mm]	84.0	86.0	85.0	85.0	82.0	73.0	83.0	83.0
b2 [mm]	220.0	220.0	224.5	220.0	219.0	221.0	273.0	270.0
Weight [kg]	2.80	3.00	3.40	3.80	4.10	4.50	6.0	6.80

Denotations / product codes

KNSR x/90 - CZ 2

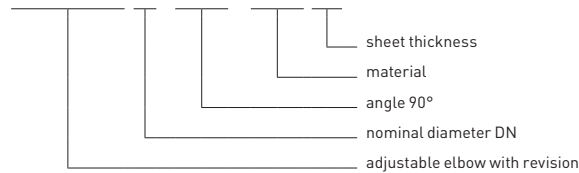
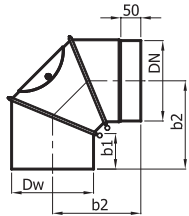

Destination	D	D - smoke ducts
Material	CZ	CZ - mild steel DC01
Sheet thickness s	2	2 - sheet thickness 2,0 mm

11. Adjustable elbow 45° KNS/45



Diameter DN	Ø120	Ø130	Ø150	Ø160	Ø180	Ø200	Ø220	Ø250
Dw	121.0	131.0	151.0	161.0	181.0	201.0	221.0	251.0
b1 [mm]	84.0	86.0	85.0	85.0	82.0	73.0	83.0	83.0
b2 [mm]	172.0	170.0	162.0	158.0	151.0	144.0	165.0	165.0
Weight [kg]	1.80	1.90	2.10	2.20	2.35	2.50	3.30	3.30

Denotations / product codes

KNS x/45 - CZ 2

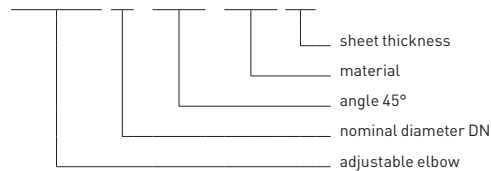
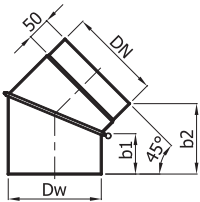

Destination	D	D - smoke ducts
Material	CZ	CZ - mild steel DC01
Sheet thickness s	2	2 - sheet thickness 2,0 mm

12. Adjustable elbow with revision- 4 segments KNSR/UNI



Available configurations

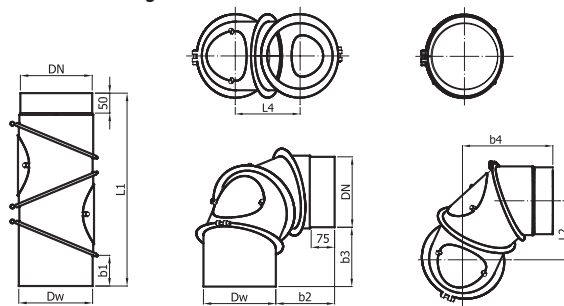

Diameter DN	Ø120	Ø130	Ø150	Ø160	Ø180	Ø200	Ø220	Ø250
Dw [mm]	121.0	131.0	151.0	161.0	181.0	201.0	221.0	251.0
b1 [mm]	84.0	86.0	85.0	85.0	82.0	73.0	83.0	83.0
b2 [mm]	205.0	190.0	180.0	160.0	160.0	145.0	220.0	200.0
b3 [mm]	205.0	190.0	180.0	160.0	160.0	145.0	220.0	200.0
b4 [mm]	265.0	285.0	275.0	280.0	290.0	300.0	335.0	330.0
b5 [mm]	225.0	220.0	200.0	200.0	200.0	200.0	280.0	260.0
L1 [mm]	535.0	535.0	525.0	500.0	515.0	505.0	650.0	640.0
L2 [mm]	200.0	200.0	190.0	160.0	180.0	200.0	240.0	230.0
L3 [mm]	440.0	440.0	440.0	415.0	430.0	420.0	540.0	535.0
L4 [mm]	225.0	220.0	200.0	200.0	200.0	200.0	280.0	260.0
Weight [kg]	3.90	4.30	4.80	5.20	5.70	6.30	8.80	9.60

Denotations / product codes

KNSR x/UNI - CZ 2

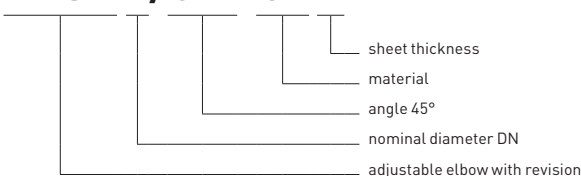
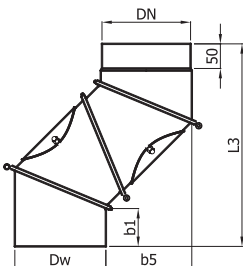

Destination	D	D - smoke ducts
Material	CZ	CZ - mild steel DC01
Sheet thickness s	2	2 - sheet thickness 2,0 mm

13. Adjustable elbow replacement clamp; Adjustable elbow replacement version ceramic seal

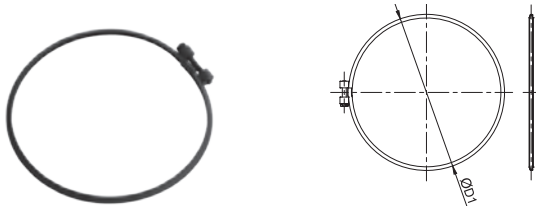

Diameter DN	Ø120	Ø130	Ø150	Ø160	Ø180	Ø200	Ø220	Ø250
D1	152	162	184	196	217	240	260	300
Weight [kg]	0.1	0.1	0.1	0.1	0.1	0.1	0.1	0.1

CAUTION! Sold in sets of 2 pcs.

Denotations / product codes

KNSR-OPASKA x-CZ 2

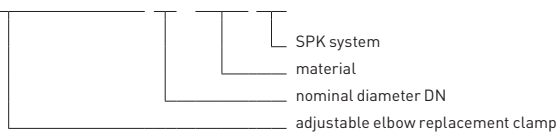

Denotations / product codes

KNSR-USZCZELKA-CZ2

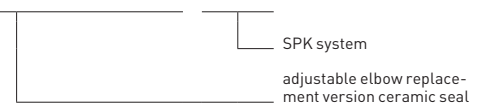

14. Solid elbow 90° with revision KSR/90



Diameter DN	Ø120	Ø130	Ø150	Ø160	Ø180	Ø200	Ø220	Ø250
Dw [mm]	121.0	131.0	151.0	161.0	181.0	201.0	221.0	251.0
b1 [mm]	84.0	94.0	95.0	95.0	87.0	84.0	95.0	95.0
b2 [mm]	220.0	220.0	235.5	235.0	235.0	235.0	310.0	310.0
Weight [kg]	2.80	3.00	3.40	3.60	4.10	4.50	6.0	6.80

Denotations / product codes

KSR x/90-CZ 2

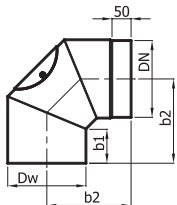

Destination	D	D - smoke ducts
Material	CZ	CZ - mild steel DC01
Sheet thickness s	2	2 - sheet thickness 2,0 mm

15. Solid elbow 90° KS/90



Diameter DN	Ø120	Ø130	Ø150	Ø160	Ø180	Ø200	Ø220	Ø250
Dw [mm]	121.0	131.0	151.0	161.0	181.0	201.0	221.0	251.0
b1 [mm]	84.0	94.0	95.0	95.0	87.0	84.0	95.0	95.0
b2 [mm]	220.0	220.0	235.5	235.0	235.0	235.0	310.0	310.0
Weight [kg]	2.80	3.00	3.40	3.60	4.10	4.50	6.0	6.80

Denotations / product codes

KS x/90-CZ 2

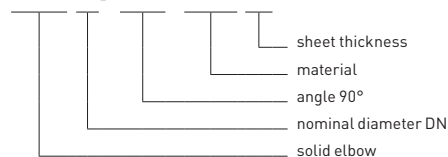
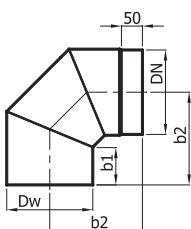

Destination	D	D - smoke ducts
Material	CZ	CZ - mild steel DC01
Sheet thickness s	2	2 - sheet thickness 2,0 mm

16. Solid elbow 45° KS/45

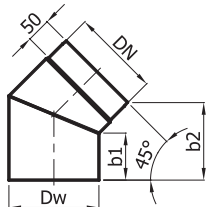

Diameter DN	Ø120	Ø130	Ø150	Ø160	Ø180	Ø200	Ø220	Ø250
Dw [mm]	121.0	131.0	151.0	161.0	181.0	201.0	221.0	251.0
b1 [mm]	96	94.0	95.0	95.0	87.0	84.0	95.0	95.0
b2 [mm]	172.0	170.0	162.0	158.0	151.0	144.0	165.0	165.0
Weight [kg]	1.80	1.90	2.10	2.20	2.35	2.50	3.33	3.90

Denotations / product codes

KS x/45-CZ 2

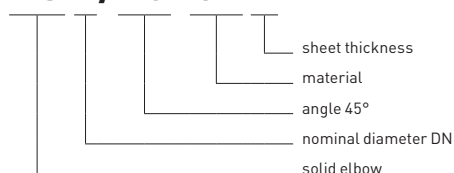

Destination	D	D - smoke ducts
Material	CZ	CZ - mild steel DC01
Sheet thickness s	2	2 - sheet thickness 2,0 mm

17. Solid elbow 45° with revision KSR/45

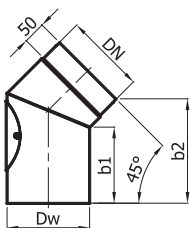

Diameter DN	Ø120	Ø130	Ø150	Ø160	Ø180	Ø200	Ø220	Ø250
Dw [mm]	121.0	131.0	151.0	161.0	181.0	201.0	221.0	251.0
b1 [mm]	187.0	184.0	174.0	170.0	170.0	165.0	145.0	132.0
b2 [mm]	258.0	254.0	245.0	241.0	235.0	228.0	216.0	204.0
Weight [kg]	2.10	2.30	2.60	2.80	3.10	3.50	3.80	4.30

Denotations / product codes

KSR x/45-CZ 2

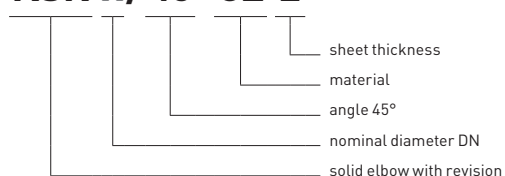

Destination	D	D - smoke ducts
Material	CZ	CZ - mild steel DC01
Sheet thickness s	2	2 - sheet thickness 2,0 mm

18. Bent elbow - high KG

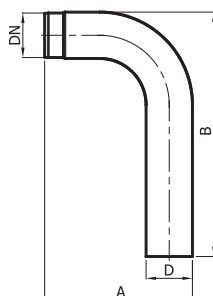

Diameter DN	Ø120	Ø130	Ø150
ØD [mm]	125.0	135.0	155.0
ØDk [mm]	120.0	130.0	150.0
A [mm]	398.0	420.0	460.0
B [mm]	645.0	640.0	645.0
Weight [kg]	5.1	5.5	6.6

Denotations / product codes

KG x/90-CZ 2/W

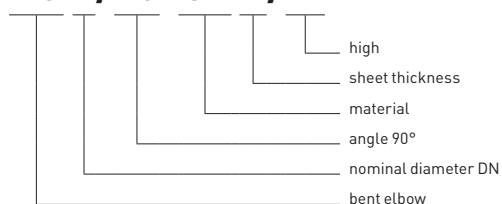

Destination	D	D - smoke ducts
Material	CZ	CZ - mild steel DC01
Sheet thickness s	2	2 - sheet thickness 2,0 mm

19. Bent elbow high-short KG



Diameter DN	Ø120	Ø130	Ø150
ØD [mm]	125.0	135.0	155.0
ØDk [mm]	120.0	130.0	150.0
A [mm]	318.0	340.0	380.0
B [mm]	645.0	640.0	645.0
Weight [kg]	4.7	5.0	6.0

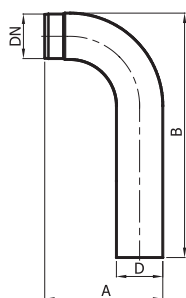

Denotations / product codes

KG x/90-CZ 2/WK

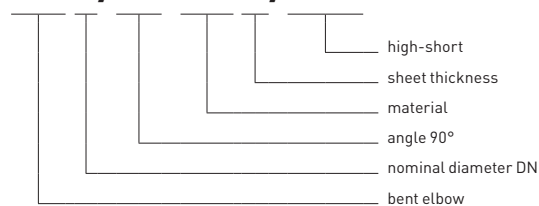

Destination	D	D - smoke ducts
Material	CZ	CZ - mild steel DC01
Sheet thickness s	2	2 - sheet thickness 2,0 mm

20. Bent elbow high with revision KGR



Diameter DN	Ø120	Ø130	Ø150
ØD [mm]	125.0	135.0	155.0
ØDk [mm]	120.0	130.0	150.0
A [mm]	398.0	420.0	460.0
B [mm]	645.0	640.0	645.0
Weight [kg]	5.2	5.6	6.7

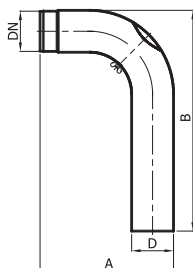

Denotations / product codes

KGR x/90-CZ 2/W

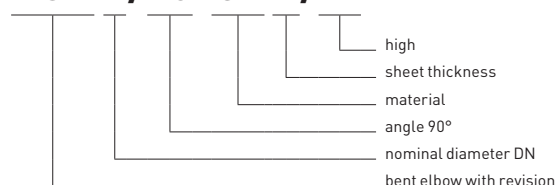

Destination	D	D - smoke ducts
Material	CZ	CZ - mild steel DC01
Sheet thickness s	2	2 - sheet thickness 2,0 mm

21. Bent elbow high-short with revision KGR



Diameter DN	Ø120	Ø130	Ø150
ØD [mm]	125.0	135.0	155.0
ØDk [mm]	120.0	130.0	150.0
A [mm]	318.0	340.0	380.0
B [mm]	645.0	640.0	645.0
Weight [kg]	4.7	5.0	6.1

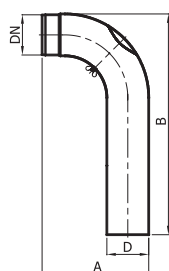

Denotations / product codes

KGR x/90-CZ 2/WK

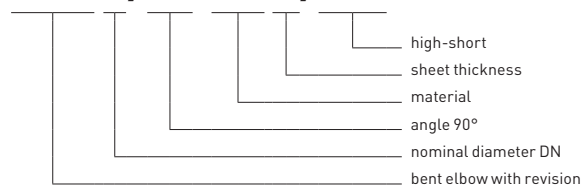

Destination	D	D - smoke ducts
Material	CZ	CZ - mild steel DC01
Sheet thickness s	2	2 - sheet thickness 2,0 mm

22. Bent elbow high with chimney damper KGS



Diameter DN	Ø120	Ø130	Ø150
ØD [mm]	125.0	135.0	155.0
ØDk [mm]	120.0	130.0	150.0
A [mm]	398.0	420.0	460.0
B [mm]	645.0	640.0	645.0
Weight [kg]	5.4	5.8	6.9

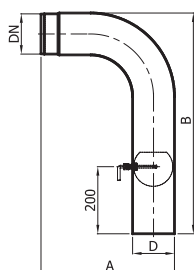

Denotations / product codes

KGS x/90-CZ 2/W

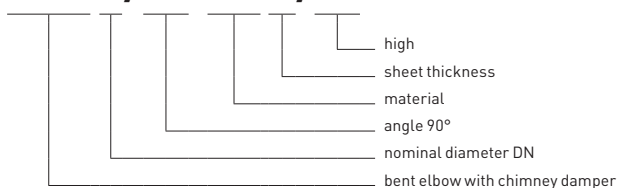

Destination	D	D - smoke ducts
Material	CZ	CZ - mild steel DC01
Sheet thickness s	2	2 - sheet thickness 2,0 mm

23. Bent elbow high-short with chimney damper KGS



Diameter DN	Ø120	Ø130	Ø150
ØD [mm]	125.0	135.0	155.0
ØDk [mm]	120.0	130.0	150.0
A [mm]	318.0	340.0	380.0
B [mm]	645.0	640.0	645.0
Weight [kg]	4.9	5.2	6.3

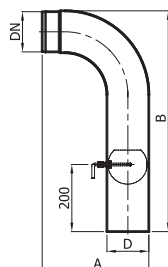

Denotations / product codes

KGS x/90-CZ 2/WK

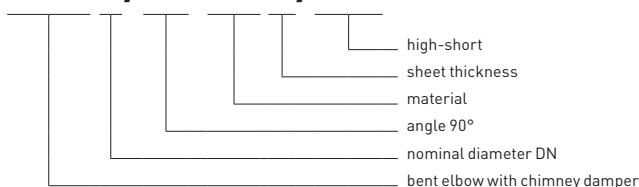

Destination	D	D - smoke ducts
Material	CZ	CZ - mild steel DC01
Sheet thickness s	2	2 - sheet thickness 2,0 mm

24. Bent elbow high with revision and chimney damper KGSR



Diameter DN	Ø120	Ø130	Ø150
ØD [mm]	125.0	135.0	155.0
ØDk [mm]	120.0	130.0	150.0
A [mm]	398.0	420.0	460.0
B [mm]	645.0	640.0	645.0
Weight [kg]	5.5	5.8	7.0

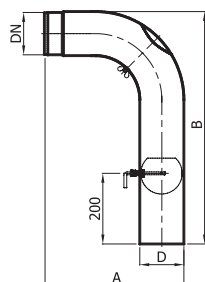

Denotations / product codes

KGSR x/90-CZ 2/W

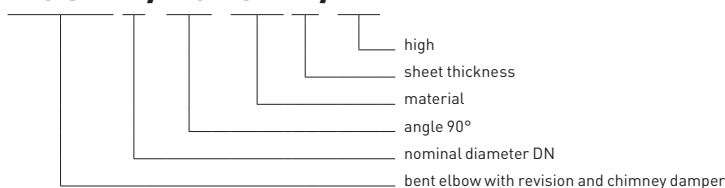

Destination	D	D - smoke ducts
Material	CZ	CZ - mild steel DC01
Sheet thickness s	2	2 - sheet thickness 2,0 mm

25. Bent elbow high-short with revision and chimney damper KGSR

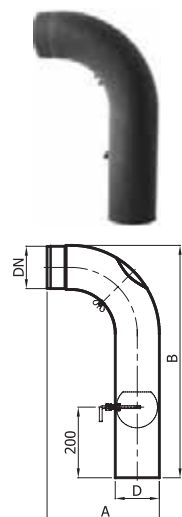

Diameter DN	Ø120	Ø130	Ø150
ØD [mm]	125.0	135.0	155.0
ØDk [mm]	120.0	130.0	150.0
A [mm]	318.0	340.0	380.0
B [mm]	645.0	640.0	645.0
Weight [kg]	5.0	5.3	6.4

Denotations / product codes

KGSR x/90-CZ 2/WK

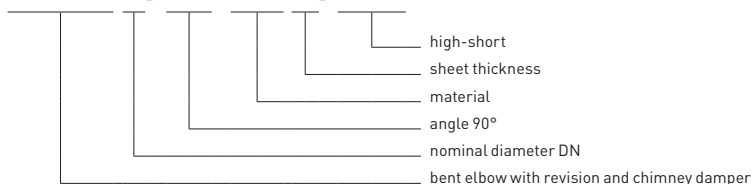

Destination	D	D - smoke ducts
Material	CZ	CZ - mild steel DC01
Sheet thickness s	2	2 - sheet thickness 2,0 mm

26. Bent elbow low KG

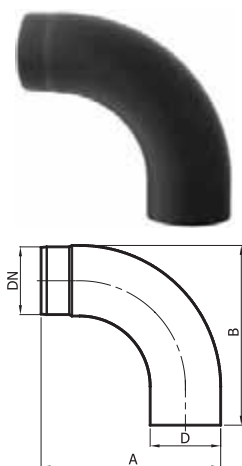

Diameter DN	Ø120	Ø130	Ø150
ØD [mm]	125.0	135.0	155.0
ØDk [mm]	120.0	130.0	150.0
A [mm]	318.0	340.0	380.0
B [mm]	318.0	340.0	380.0
Weight [kg]	2.6	3.0	3.8

Denotations / product codes

KG x/90-CZ 2/N

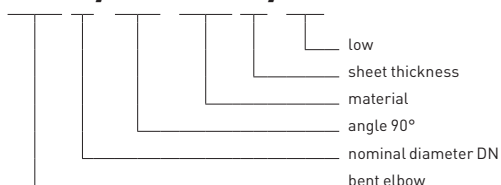

Destination	D	D - smoke ducts
Material	CZ	CZ - mild steel DC01
Sheet thickness s	2	2 - sheet thickness 2,0 mm

27. Bent elbow low with revision KGR

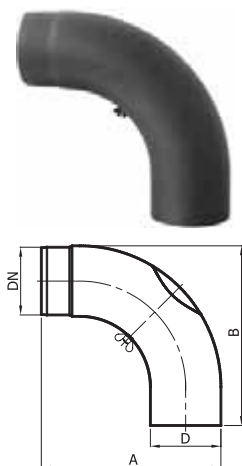

Diameter DN	Ø120	Ø130	Ø150
ØD [mm]	125.0	135.0	155.0
ØDk [mm]	120.0	130.0	150.0
A [mm]	318.0	340.0	380.0
B [mm]	318.0	340.0	380.0
Weight [kg]	2.7	3.1	3.9

Denotations / product codes

KGR x/90-CZ 2/N

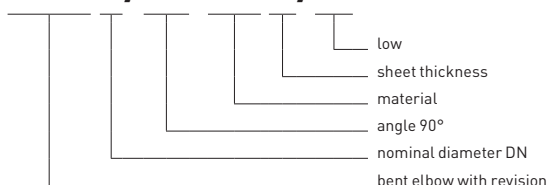

Destination	D	D - smoke ducts
Material	CZ	CZ - mild steel DC01
Sheet thickness s	2	2 - sheet thickness 2,0 mm

28. Bent elbow 45° KG



Diameter DN	Ø120	Ø130	Ø150
ØD [mm]	125.0	135.0	155.0
ØDk [mm]	120.0	130.0	150.0
A [mm]	208.0	222.0	248.0
B [mm]	294.0	308.0	336.0
Weight [kg]	1.7	1.9	2.4

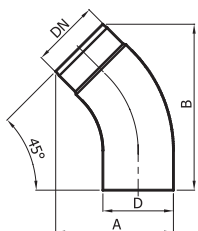

Denotations / product codes

KG x/45-CZ 2

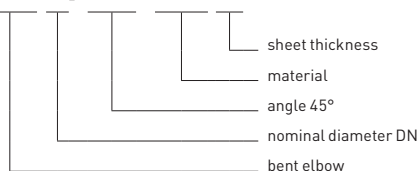

Destination	D	D - smoke ducts
Material	CZ	CZ - mild steel DC01
Sheet thickness s	2	2 - sheet thickness 2,0 mm

29. Bent elbow 45° with revision KGR



Diameter DN	Ø120	Ø130	Ø150
ØD [mm]	125.0	135.0	155.0
ØDk [mm]	120.0	130.0	150.0
A [mm]	208.0	222.0	248.0
B [mm]	294.0	308.0	336.0
Weight [kg]	1.80	2.0	2.5

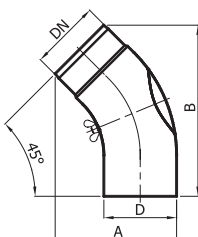

Denotations / product codes

KGR x/45-CZ 2

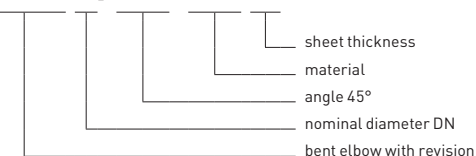

Destination	D	D - smoke ducts
Material	CZ	CZ - mild steel DC01
Sheet thickness s	2	2 - sheet thickness 2,0 mm

30. Reducers RD - reversed



Denotations / product codes

RD x/y-CZ 2/II

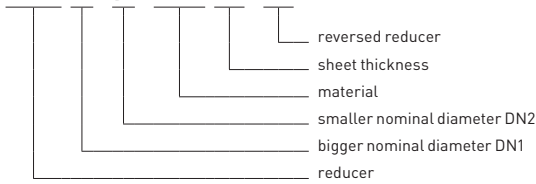

Denotations / product codes

RD x/y-CZ 2/II-S

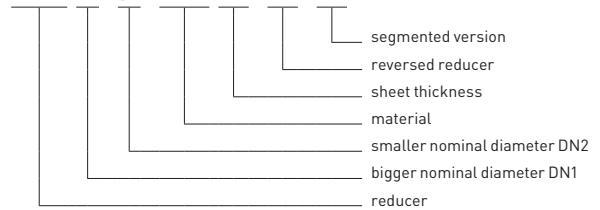

Table of versions and available diameters

Diameter	DN 2								
	Ø120	Ø130	Ø150	Ø160	Ø180	Ø200	Ø220	Ø250	
Ø120	-	RD-II	RD-II	RD-II	RD-II-S	RD-II-S	RD-II-S	RD-II-S	
Ø130	RD-I	-	RD-II	RD-II	RD-II	RD-II-S	RD-II-S	RD-II-S	
Ø150	RD-I	RD-I	-	RD-II	RD-II	RD-II	RD-II-S	RD-II-S	
Ø160	RD-I	RD-I	RD-I	-	RD-II	RD-II	RD-II-S	RD-II-S	
Ø180	RD-I-S	RD-I	RD-I	RD-I	-	RD-II	RD-II	RD-II-S	
Ø200	RD-I-S	RD-I-S	RD-I	RD-I	RD-I	-	RD-II	RD-II	
Ø220	RD-I-S	RD-I-S	RD-I-S	RD-I-S	RD-I	RD-I	-	RD-II	
Ø250	RD-I-S	RD-I-S	RD-I-S	RD-I-S	RD-I-S	RD-I	RD-I	-	

Destination	D	D - smoke ducts
Material	CZ	CZ - mild steel DC01
Sheet thickness	2	2 - sheet thickness 2,0 mm

31. Reducers RD - standard



Denotations / product codes

RD x/y-CZ 2/I

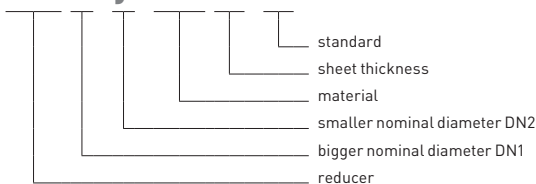

Denotations / product codes

RD x/y-CZ 2/I-S

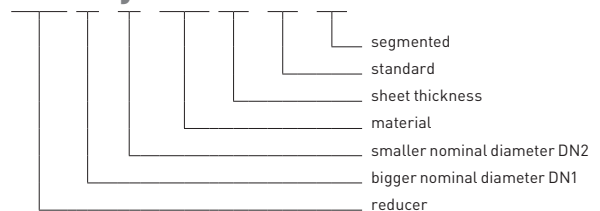

32. Round to square reducer RDKW



Diameter DN	Dimensions Aw x Bw [mm]									
	122 x 122	135 x 189	142 x 142	142 x 162	152 x 152	162 x 162	171 x 171	180 x 180	192 x 192	200 x 200
Ø120	1,8 kg	-	-	-	-	-	-	-	-	-
Ø130	1,85 kg	-	2,00 kg	-	2,05 kg	-	-	-	-	-
Ø150	1,95 kg	-	2,10 kg	-	2,10 kg	2,30 kg	2,35 kg	2,40 kg	-	-
Ø160	-	-	2,15 kg	-	2,15 kg	2,40 kg	2,45 kg	2,50 kg	2,60 kg	2,70 kg
Ø180	-	2,70 kg	2,25 kg	2,40 kg	2,30 kg	2,50 kg	2,55 kg	2,60 kg	2,70 kg	2,80 kg
Ø200	-	2,90 kg	2,35 kg	-	2,45 kg	2,60 kg	2,65 kg	2,70 kg	2,80 kg	2,90 kg

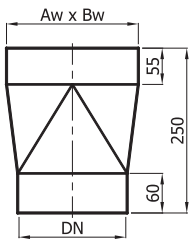

Denotations / product codes

RD kw Ax B/x-CZ 2

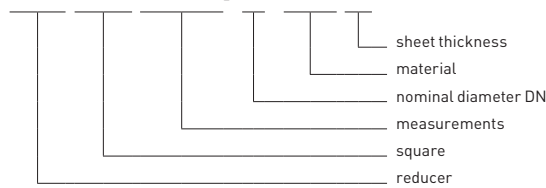

Destination	D	D - smoke ducts
Material	CZ	CZ - mild steel DC01
Sheet thickness s	2	2 - sheet thickness 2,0 mm

33. Chimney damper with short handle SZK



Chimney dampers are produced in versions:

- with long handle for diameters 180, 200, 220 and 250
- with short handle 120, 130, 150 and 160

Diameter DN	Ø120	Ø130	Ø150	Ø160
Dw [mm]	121.0	131.0	151.0	161.0
L [mm]	193.0	203.0	223.0	223.0
Weight [kg]	3.20	3.50	4.00	4.50

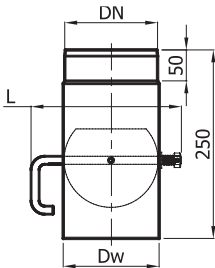

Denotations / product codes

SZK x-CZ 2

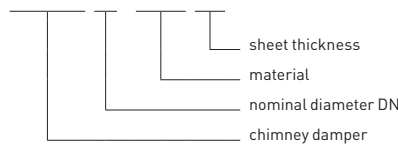

Destination	D	D - smoke ducts
Material	CZ	CZ - mild steel DC01
Sheet thickness s	2	2 - sheet thickness 2,0 mm

34. Chimney damper „do it yourself” set with short handle SZK-SET



Chimney dampers are produced in versions:

- with long handle for diameters 180, 200, 220 and 250
- with short handle 120, 130, 150 and 160

Diameter DN	Ø120	Ø130	Ø150	Ø160
B [mm]	97.5	105.0	110.0	118.0
Dp [mm]	117.0	127.0	147.0	157.0
L [mm]	193.0	203.0	223.0	223.0
Weight [kg]	1.65	1.80	2.00	2.20

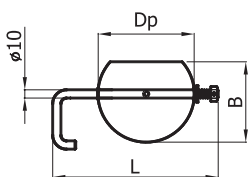

Denotations / product codes

SZK-SET x-K-CZ 2

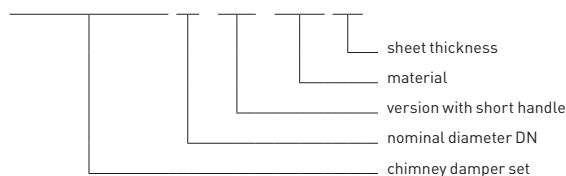

Destination	D	D - smoke ducts
Material	CZ	CZ - mild steel DC01
Sheet thickness s	2	2 - sheet thickness 2,0 mm

35. Chimney damper with long handle SZK



Chimney dampers are produced in versions

- with long handle for diameters 180, 200, 220 and 250
- with short handle 120, 130, 150 and 160

Denotations / product codes

SZK x-CZ 2

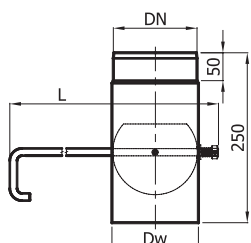
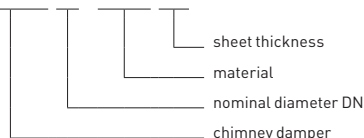

Diameter DN	Ø180	Ø200	Ø220	Ø250
Dw [mm]	181.0	201.0	221.0	251.0
L [mm]	690.0	710.0	730.0	760.0
Weight [kg]	3.40	3.60	3.90	4.30

Destination	D	D - smoke ducts
Material	CZ	CZ - mild steel DC01
Sheet thickness s	2	2 - sheet thickness 2,0 mm

36. Chimney damper „do it yourself” set with long handle SZK-SET



Chimney dampers are produced in versions:

- with long handle for diameters 180, 200, 220 and 250
- with short handle 120, 130, 150 and 160

Denotations / product codes

SZK-SET x-D-CZ 2

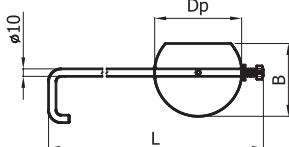
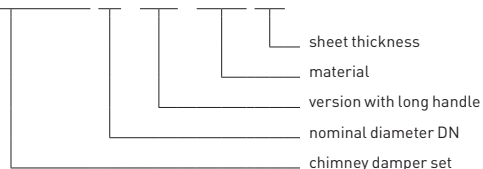

Diameter DN	Ø180	Ø200
B [mm]	142.5	154.5
Dp [mm]	177.0	197.0
L [mm]	690.0	710.0
Weight [kg]	2.70	3.00

Destination	D	D - smoke ducts
Material	CZ	CZ - mild steel DC01
Sheet thickness s	2	2 - sheet thickness 2,0 mm

37. Chimney damper with blockade SZKB



In standard version damper is produced with short handle.

Denotations / product codes

SZKB x-CZ 2

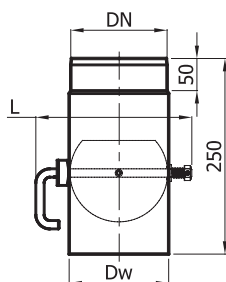
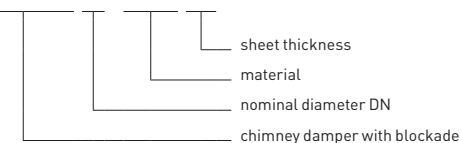

Diameter DN	Ø120	Ø130	Ø150	Ø160
Dw [mm]	121.0	131.0	151.0	161.0
L [mm]	193.0	203.0	223.0	223.0
Weight [kg]	3.20	3.50	4.00	4.50

Destination	D	D - smoke ducts
Material	CZ	CZ - mild steel DC01
Sheet thickness s	2	2 - sheet thickness 2,0 mm

38. Chimney damper knob SZKŻ-REG



Denotations / product codes

SZKŻ-REG

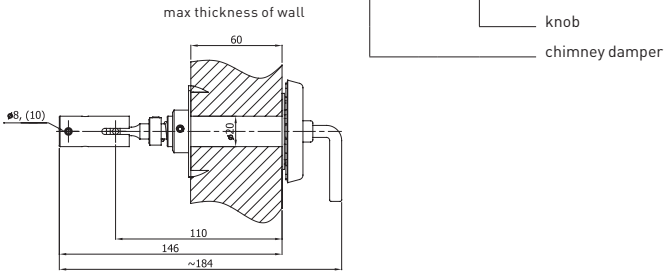

Destination	S	-	S - flue ducts
	-	D	D - smoke ducts
Material	CH	CH	CH - stainless steel 1.4301
	ML	ML	ML - stainless steel 1.4301 powder coated

39. Chimney damper knob SZKŻ-REG-LIGHT



Denotations / product codes

SZK-REG-LIGHT-B/CZ

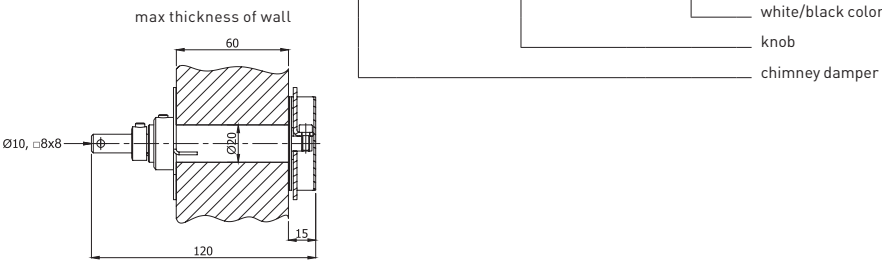

Destination	S	-	S - flue ducts
	-	D	D - smoke ducts
Material	CZ	CZ	CZ - mild steel DC01 powder coated

40. Round and rectangular under surface chimney damper knobs

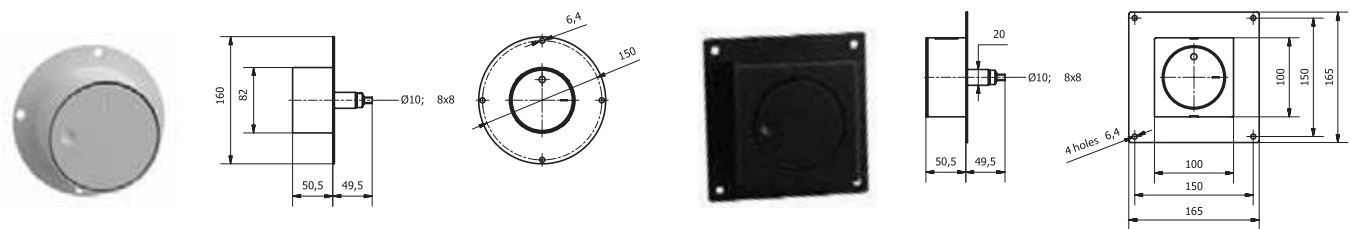

Denotations / product codes

SZKŻ - REG-OK - ML B/CZ

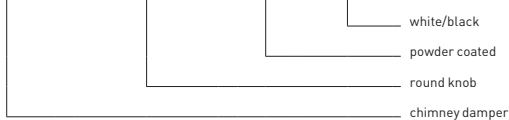

Denotations / product codes

SZKŻ-REG-KW-ML B/CZ

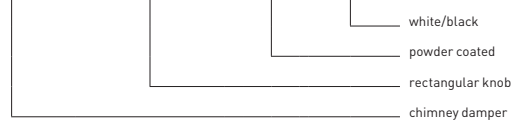

Destination	S	-	S - flue ducts
	-	D	D - smoke ducts
Material	CZ	CZ	CZ - mild steel DC01 powder coated

41. Chimney damper knob ...OS

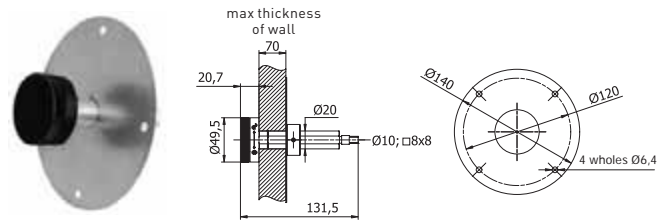
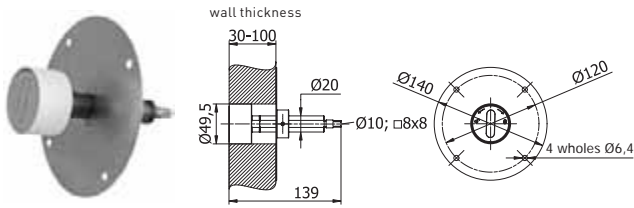

Denotations / product codes

SZKŻ - REG-OS / P - ML - ...

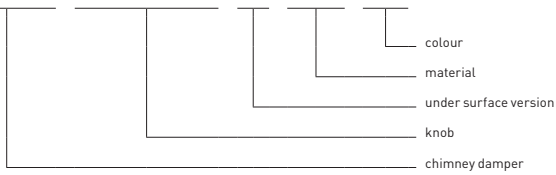

Denotations / product codes

SZKŻ - REG-OS / N - ML - ...

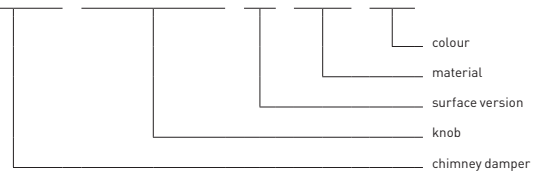

Destination	S	-	S - flue ducts
	-	D	D - smoke ducts
Material	ML	ML	ML - aluminium powder coated
	B	B	B - white
Colour	CZ	CZ	CZ - black

42. Flexible shaft SZK-REG-WG and extension SZKŻ-REG-PW600

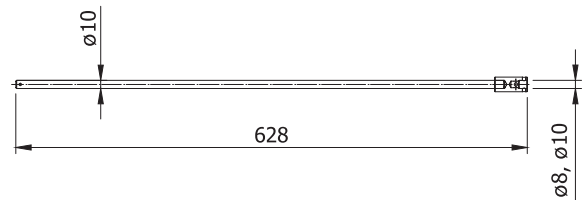
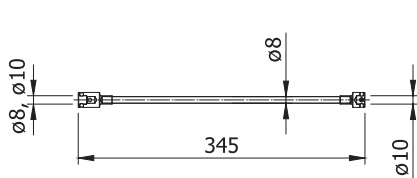

Denotations / product codes

SZK-REG-WG

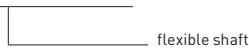

Denotations / product codes

SZKŻ-REG-PW600



Destination	S	-	S - flue ducts
	-	D	D - smoke ducts
Material	CZ	CZ	CZ - steel sheet (black)

Compatible with chimney dampers with rod diameters Ø8 and Ø10 mm and knobs: SZKŻ-REG and SZKŻ-REG-LIGHT

43. Round, rectangular joint

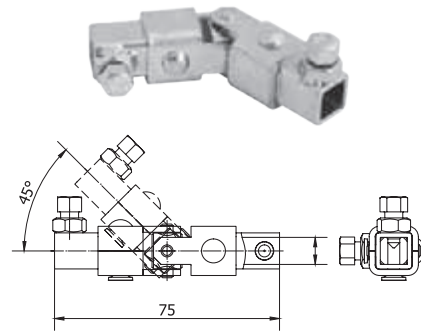
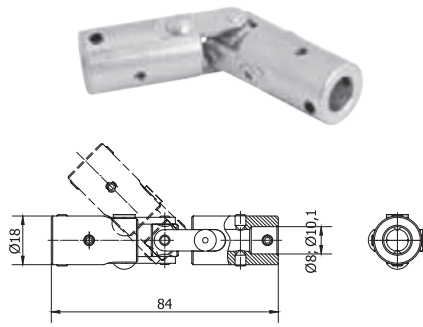

Denotations / product codes

Denotations / product codes

SZKŻ-REG-PGO

SZKŻ-REG-PGK

round joint

rectangular joint

44. Wall insert to ceramic chimneys WKC; WKC-S

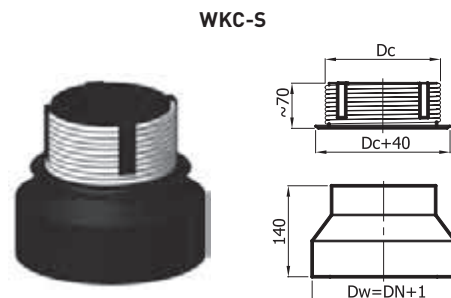
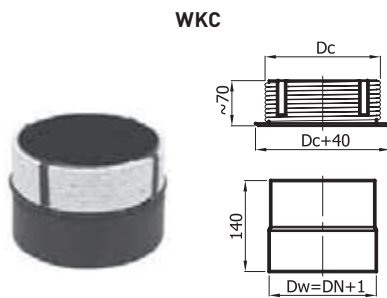

Denotations / product codes

Denotations / product codes

WKC x/y-CZ 2

WKC x/y-CZ 2-S

sheet thickness
material
inner diameter of ceramic tee Dc
nominal diameter DN
wall insert to ceramic chimneys

segmented version
sheet thickness
material
inner diameter of ceramic tee Dc
nominal diameter DN
wall insert to ceramic chimneys

This wall insert protects ceramic chimney tees from damages caused by thermal expansion of metal elements of the chimney connection.

Table of versions and available diameters

Diameter DN	Diameter DC																	
	Ø120		Ø130		Ø140		Ø150		Ø160		Ø180		Ø200		Ø220		Ø250	
Version	Weight [kg]	Version	Weight [kg]	Version	Weight [kg]	Version	Weight [kg]	Version	Weight [kg]	Version	Weight [kg]	Version	Weight [kg]	Version	Weight [kg]	Version	Weight [kg]	
Ø120	WKC	1,10	WKC	1,15	WKC	1,30	WKC	1,30	WKC	1,40	WKC	1,60	WKC-S	1,85	WKC-S	-	WKC-S	-
Ø130	WKC	1,15	WKC	1,20	WKC	1,35	WKC	1,35	WKC	1,50	WKC	1,60	WKC	1,65	WKC-S	-	WKC-S	-
Ø150	WKC	1,25	WKC	1,30	WKC	1,40	WKC	1,50	WKC	1,60	WKC	1,65	WKC	1,70	WKC	1,90	WKC-S	-
Ø160	WKC-S	1,70	WKC-S	1,75	WKC	1,50	WKC	1,60	WKC	1,65	WKC	1,70	WKC	1,75	WKC	1,90	WKC	1,95
Ø180	WKC-S	1,85	WKC-S	1,90	WKC-S	1,95	WKC-S	2,00	WKC	1,75	WKC	1,80	WKC	1,85	WKC	2,00	WKC	2,00
Ø200	WKC-S	1,95	WKC-S	2,00	WKC-S	2,05	WKC-S	2,10	WKC-S	2,15	WKC	1,90	WKC	1,95	WKC	2,05	WKC	2,05
Ø220	WKC-S	-	WKC-S	-	WKC-S	-	WKC-S	-	WKC-S	-	WKC	2,00	WKC	2,05	WKC	2,10	WKC	2,20
Ø250	WKC-S	-	WKC-S	-	WKC-S	-	WKC-S	-	WKC-S	-	WKC-S	-	WKC-S	2,35	WKC	2,20	WKC	2,30

Destination	D	D - smoke ducts
Material	CZ	CZ - mild steel DC01
Sheet thickness s	2	2 - sheet thickness 2,0 mm

45. Double - walled wall insert WD

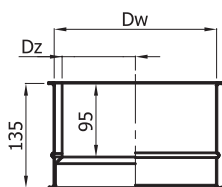

Diameter DN	Ø120	Ø130	Ø150	Ø160	Ø180	Ø200	Ø220	Ø250
Dz [mm]	110.0	120.0	140.0	150.0	170.0	190.0	210.0	240.0
Dw [mm]	128.0	138.0	158.0	168.0	188.0	208.0	228.0	258.0
Weight [kg]	0.65	0.70	0.85	0.90	1.00	1.10	1.20	1.25

Denotations / product codes

WD x - CZ

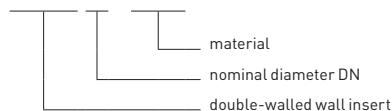

CAUTION!

Double-walled insert is used to secure connection of the SPK element to chimney duct with metal insert.

Destination	D	D - smoke ducts
Material	CZ	CZ - mild steel DC01
Sheet thickness s	8	8 - sheet thickness 0,8 mm

46. Single-walled wall insert WJ

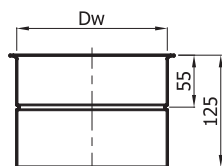

Diameter DN	Ø120	Ø130	Ø150	Ø160	Ø180	Ø200	Ø220	Ø250
Dw [mm]	128.0	138.0	158.0	168.0	188.0	208.0	228.0	258.0
Weight [kg]	0.30	0.35	0.40	0.42	0.45	0.50	0.55	0.60

Denotations / product codes

WJ x - CZ

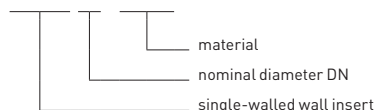

Destination	D	D - smoke ducts
Material	CZ	CZ - mild steel DC01
Sheet thickness s	8	8 - sheet thickness 0,8 mm

47. Female connector with anti-condensation protection ZZ

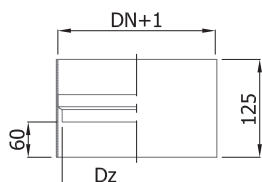

Diameter DN	Ø120	Ø130	Ø150	Ø160	Ø180	Ø200	Ø220	Ø250
Dz [mm]	110.0	120.0	140.0	150.0	170.0	190.0	210.0	240.0
Weight [kg]	0.95	1.10	1.20	1.30	1.45	1.60	1.75	1.90

Denotations / product codes

ZZ x - CZ 2

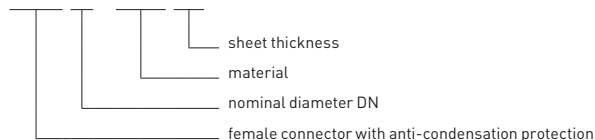

CAUTION!

Female connector allows to connect two press-formed elements to each other and divert the connection schema.

Destination	D	D - smoke ducts
Material	CZ	CZ - mild steel DC01
Sheet thickness s	2	2 - sheet thickness 2,0 mm

48. Male connector ZM



Diameter DN	Ø120	Ø130	Ø150	Ø160	Ø180	Ø200	Ø220	Ø250
Weight [kg]	0.40	0.45	0.50	0.55	0.60	0.70	0.80	0.90

Denotations / product codes

ZM x - CZ 2

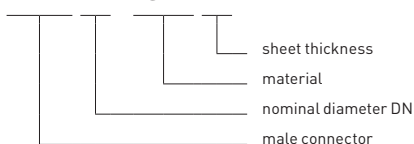

CAUTION!

Male connector allows to connect the on site cut pipe elements to other elements of the SPK system.

Destination	D	D - smoke ducts
Material	CZ	CZ - mild steel DC01
Sheet thickness	2	2 - sheet thickness 2,0 mm

49. Telescopic wall insert with ceramic rope to ceramic chimneys WKK-CS



Diameter DN	Ø150	Ø150	Ø180
DC	180.0	200.0	200.0
D	340.0	360.0	360.0
dw	151	151	181
Weight [kg]	2.95	3.20	3.20

Denotations / product codes

WKK-CS x/y/45-CZ 2

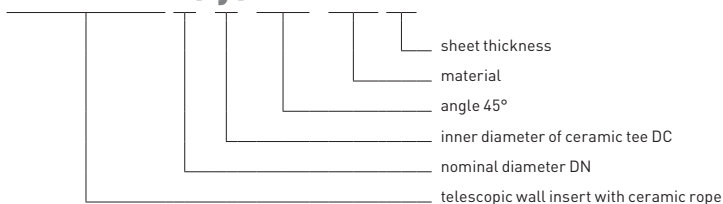

Telescopic wall insert allows to connect the stove/fireplace to the chimney at 45° angle

CAUTION!

Other inserts upon individual order

Destination	D	D - smoke ducts
Material	CZ	CZ - mild steel DC01
Sheet thickness	2	2 - sheet thickness 2,0 mm

50. Angular wall insert with ceramic rope WKK-KS (to be built in)



Diameter DN	Ø120	Ø130	Ø150	Ø160	Ø180	Ø200	Ø220	Ø250
a [mm]	130.0	140.0	160.0	170.0	190.0	210.0	230.0	260.0
b [mm]	184.0	198.0	226.0	240.0	269.0	297.0	325.0	368.0
Diameter D	280	290	310	320	340	360	380	410
Weight [kg]	0.95	1.10	1.20	1.35	1.45	1.60	1.75	2.0

Denotations / product codes

WKK-KS x/45-CZ 2

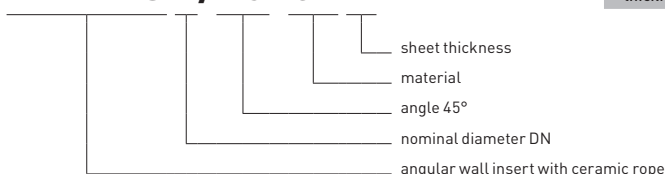

Angular insert allows to connect the stove/fireplace to the chimney at 45° angle.

CAUTION!

Pipe element ending that is put into the WKK-KS wall insert should be cut at the proper angle, so the pipe does not go into chimney duct causing an obstruction.

Destination	D	D - smoke ducts
Material	CZ	CZ - mild steel DC01
Sheet thickness	2	2 - sheet thickness 2,0 mm

51. Angular wall insert with insulation WKK (to be built in)

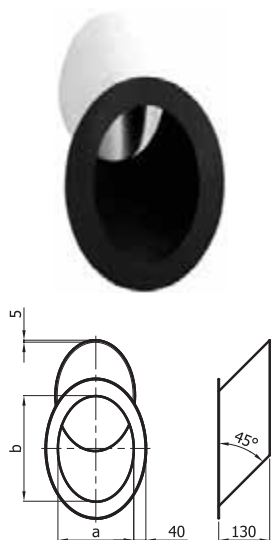

Diameter DN	Ø120	Ø130	Ø150	Ø160	Ø180	Ø200	Ø220	Ø250
a [mm]	130.0	140.0	160.0	170.0	190.0	210.0	230.0	260.0
b [mm]	184.0	198.0	226.0	240.0	269.0	297.0	325.0	368.0
Weight [kg]	0.95	1.10	1.20	1.35	1.45	1.60	1.75	1.90

Denotations / product codes

WKK x/45-CZ 2

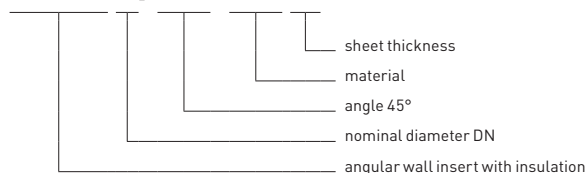

Angular wall insert allows to connect the stove to a chimney at 45° angle. Thermal insulation protects ceramic chimneys from damages caused by thermal expansion of metal elements.

CAUTION!

Pipe element ending that is put into the WKK wall insert should be cut at the proper angle, so the pipe does not go into chimney duct causing an obstruction.

Destination	D	D - smoke ducts
Material	CZ	CZ - mild steel DC01
Sheet thickness s	2	2 - sheet thickness 2,0 mm

52. Rosette ROZ



for Ø 120÷200



for Ø 220 and 250



Diameter DN	Ø120	Ø130	Ø150	Ø160	Ø180	Ø200	Ø220	Ø250
Dw [mm]	126.5	136.5	156.5	166.5	186.5	206.5	226.5	256.5
Weight [kg]	0.12	0.13	0.14	0.15	0.16	0.17	0.18	0.19

Denotations / product codes

ROZ x CZ

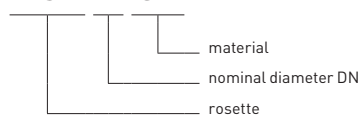

Destination	D	D - smoke ducts
Material	CZ	CZ - mild steel DC01
Sheet thickness s	6	6 - sheet thickness 0,6 mm